

VENT FRAME 100, glass black

SURFACE-MOUNTED AIR VENT FOR SUPPLY AND EXHAUST AIR

DESCRIPTION

- Surface-mounted air vent for supply and exhaust air, for flexible use in all interior spaces
- 30 millimeter wide vent frame
- Installation on ceilings and walls
- 100 percent free cross section for DN 100 air ducts
- Combination option with tecanno inserts for air regulation and filtration
- Flush cover guarantees unchanging design
- Symmetrical, flow-optimised passage of air
- Protected design patent, handcrafted in Germany
- Front made of white glass; base plate made of sheet steel with electrostatic powder coating (RAL colour 9005-20, layer thickness approx. 60 µm)

TECHNICAL DATA

Manufacturer	Tecanno
Type	Vent FRAME 100, glass black
Dimensions L x W x H (mm)	220 x 220 x 14
Connecting Piece ø (mm)	99
Weight (g)	600
Front material	Black glass
Material	Sheet steel with electrostatic powder coating
Standard RAL colour	9005-20 layer thickness approx. 60 µm
Item No.	0032100-9005-20

ACCESSORIES	VOLUME FLOW REGULATOR	FILTER INSERT	REPLACEMENT FILTER (5 x)
Item No.	10100	20100	30100

Accessories, if required, must be ordered separately.



TENDER SPECIFICATION

Tecanno air vent FRAME 100, glass black, for supply and exhaust air in design-type construction. For installation on ceilings and walls via 100 mm connecting pieces. 100 percent freely usable cross section. Can be combined with VOLUME FLOW REGULATOR or FILTER INSERT from Tecanno. The flush cover ensures a consistently slim design with a symmetrical, flow-optimized air throughput. Front made of black glass; base plate made of sheet steel with electrostatic powder coating (RAL 9005-20). Handcrafted in Germany. Registered design patent.
 Manufacturer: Tecanno
 Type: Vent FRAME 100, glass black
 Dimensions L x W x H (mm): 220 x 220 x 14
 Item No.: 0032100-9005-20

CONFIGURATION

The air vent has a 100 percent freely usable cross-section that accepts a VOLUME FLOW REGULATOR or FILTER INSERT. The VOLUME FLOW REGULATOR can be combined with a filter. Adding a VOLUME FLOW REGULATOR to the air vent allows the air flow rate to be regulated. This facilitates a variety of acoustic data and pressure reductions. For exhaust air filtration, the FILTER INSERT is ideal. The accessories can be inserted into the vent connecting piece separately. The flush cover hides the system and ensures a consistently slim design.



ACCESSORIES

- To supplement the air vents, we provide inserts for air regulation or air filtration.
- VOLUME FLOW REGULATOR: For supply or exhaust air. The VOLUME FLOW REGULATOR for air regulation can be combined with a filter (Item: REPLACEMENT FILTER) to allow exhaust air regulation.
 - FILTER INSERT: For exhaust air. FILTER INSERT cannot be regulated.
 - REPLACEMENT FILTER: 5 filters for use in the VOLUME FLOW REGULATOR or FILTER INSERT.

More information under »Acoustic data and pressure reductions« and on the relevant accessories' data sheets.

ORDERING INFORMATION

Air vent: Vent FRAME 100, glass black (Item No. 0032100-9005-20)
 Accessories*: VOLUME FLOW REGULATOR 100 (Item No. 10100) or FILTER INSERT 100 (Item No. 20100)

* The accessory (VOLUME FLOW REGULATOR and FILTER INSERT) is not included in the scope of delivery. Accessories, if required, must be ordered separately.

→ ACOUSTIC DATA AND PRESSURE REDUCTIONS
VENT FRAME 100, glass black

DEFINITIONS

Vol in m³/h: Volume flow rate per air vent
 α: Volume flow regulator opening degree in %
 Δp in Pa: Total pressure loss
 L_{WA} in dB(A): A-weighted sound power level

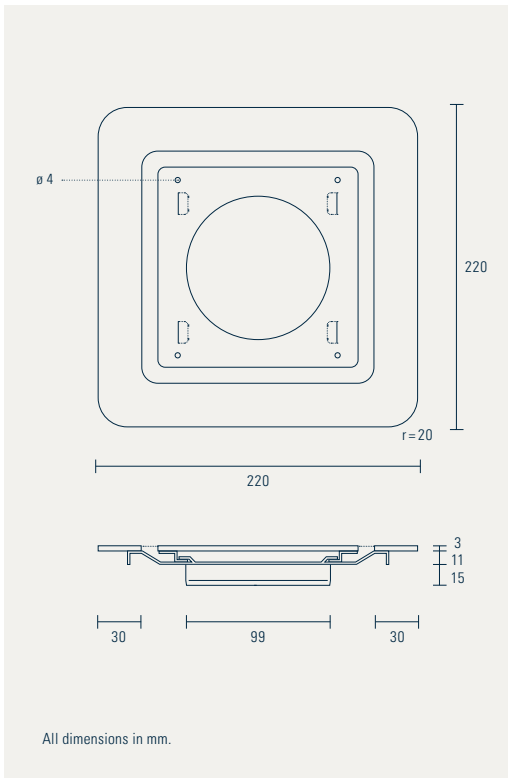
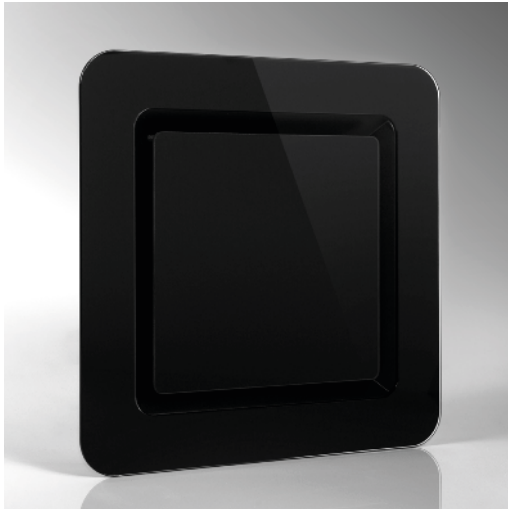

All dimensions in mm.

SOUND POWER LEVEL/PRESSURE REDUCTION

The flow rate is set by turning the volume flow regulator (α = degree of opening), which can be inserted into the vent connecting piece as required. Alternatively, the filter insert serves as a dust filter. Without any insert, the valve has a freely usable cross section. The volume flow regulator can be combined with a filter.

With volume flow regulator

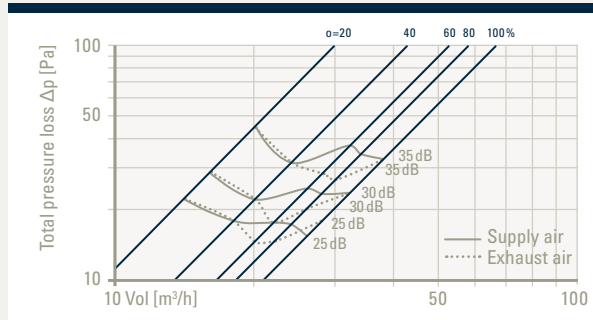

With filter insert/without insert

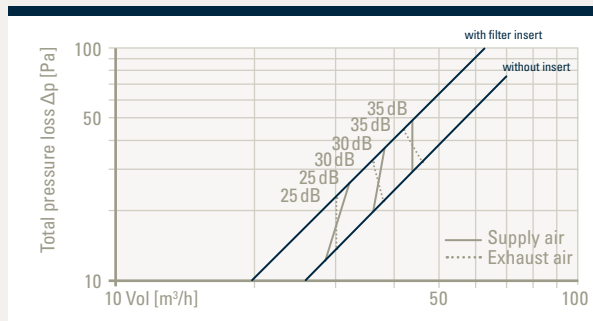

With volume flow regulator and filter

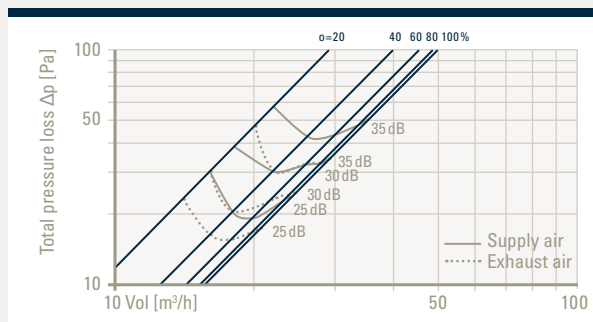

TRAJECTORY LENGTH

The trajectory length $l_{0,2}$ displayed in the diagram indicates the distance between outlet and the point in the air current (Isotherm) at which the speed drops to 0.2 m/s.

Recommended installation for supply air: Ceiling installation: 1 m distance from both sides of corner to vent edges. For exhaust air, no minimum distances.

With volume flow regulator

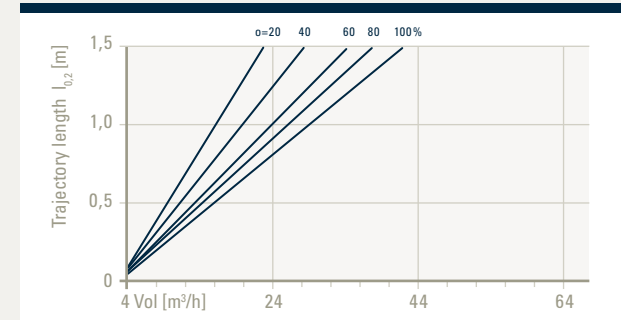

With filter insert/without insert

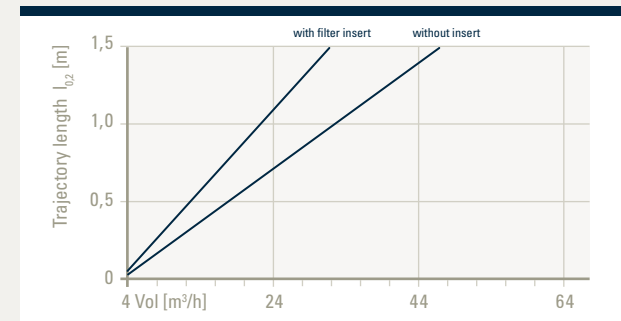

With volume flow regulator and filter

