

VENT ONE PLUS 100/125/160

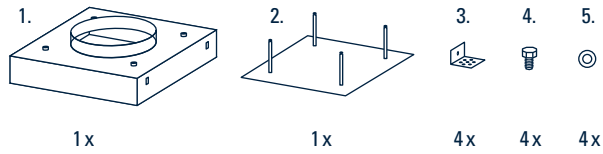

Scope of delivery

- 1. Vent housing (1x), e.g. Vent ONE PLUS 100/125
- 2. Vent cover (1x), e.g. Vent ONE PLUS 100/125
- 3. Perforated metal angle (4x)
- 4. Vent bolts (4x)
- 5. Washers (4x)

Installation instructions shown on the example of vent ONE PLUS 100/125. Vent ONE PLUS 160 in the same way.

DN 100/125

DN 160

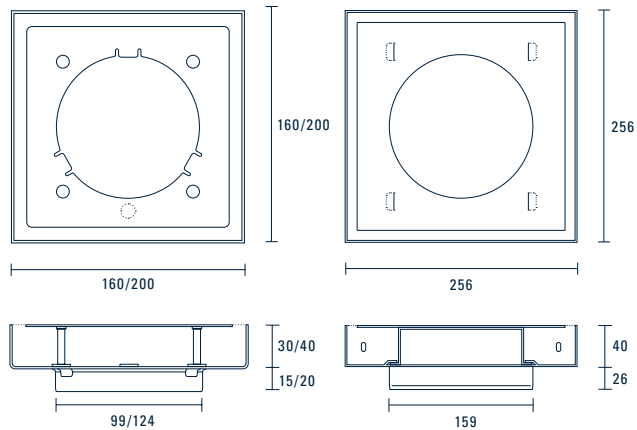

Technical drawing Vent ONE PLUS 100/125/160

All dimensions in mm.

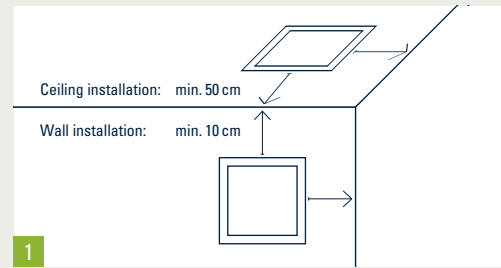

1

Recommended installation for supply air:
Ceiling installation at least 50 cm distance from both sides of corner to vent edges. Wall installation at least 10 cm distance from both sides of corner to vent edges. For exhaust air, no minimum distance.

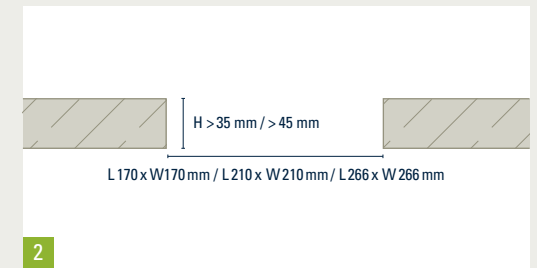

2

Build a filigran precast unit with a square opening.
Dimensions:
L 170 mm x W 170 mm x H > 35 mm (Vent ONE PLUS 100)
or L 210 mm x W 210 mm x H > 45 mm (Vent ONE PLUS 125)
or L 266 mm x W 266 mm x H > 45 mm (Vent ONE PLUS 160)

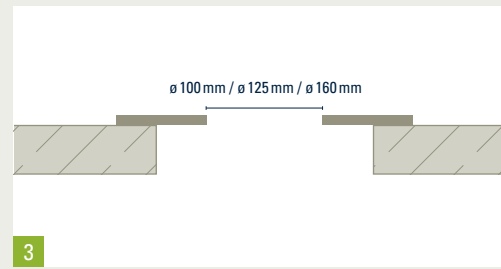

3

Place a sheet (not organic material) with a circular cut-out on it.
Cutout:
ø 100 mm (Vent ONE PLUS 100)
or ø 125 mm (Vent ONE PLUS 125)
or ø 160 mm (Vent ONE PLUS 160)

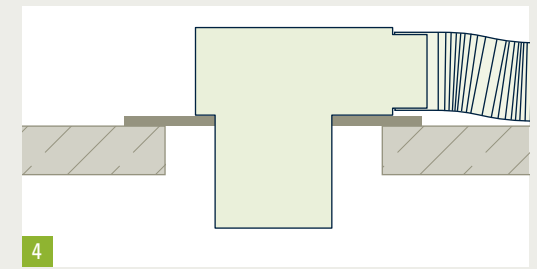

4

Insert the ceiling box into the circular cut-out and centre it accurately. Connect the ceiling box to the ventilation system. The ceiling box is not included in delivery and not available at our company.

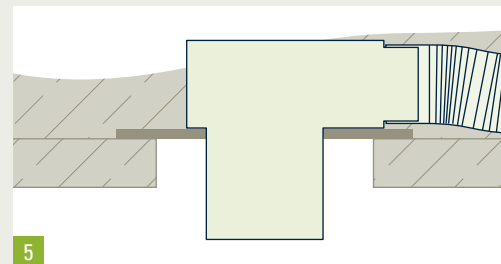

5

Pour the concrete ceiling.
Caution: Secure the ceiling box with sheet (not organic) against slipping.

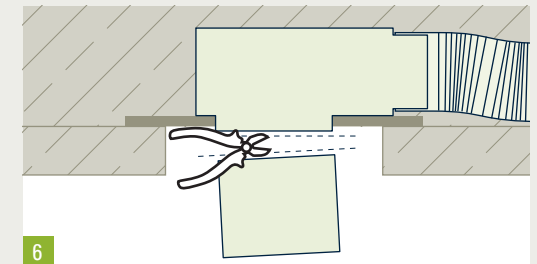

6

Shorten the ceiling box connecting piece.



→ INSTALLATION INSTRUCTIONS
FOR SOLID CONSTRUCTION

VENT ONE PLUS
100/125/160

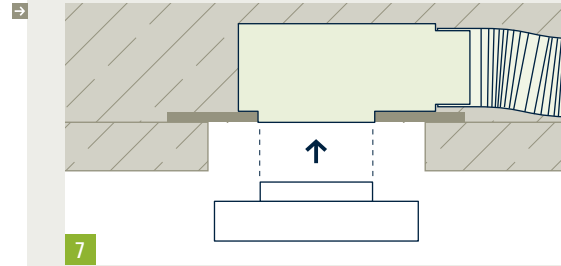

7
Place the vent in the connecting piece.

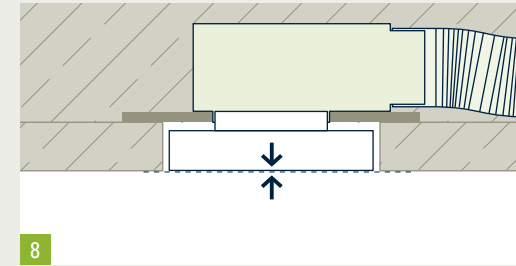

8
Align the vent flush with the lower edge of the prefabricated concrete ceiling. Caution: Please take into account the plaster thickness.

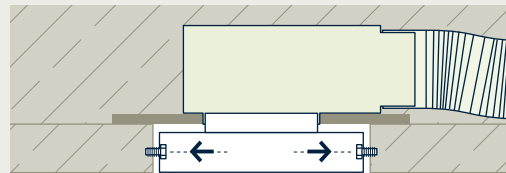

9
Use the long holes to screw the vent into the precast floors (screws should be tested by the customer).

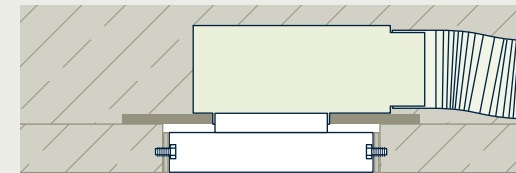

10
Fill the gaps between the housing and the ceiling. After sanding the ceiling can be painted. Now the cover can be inserted (see instructions). The vent can also be painted after a suitable pretreatment.